

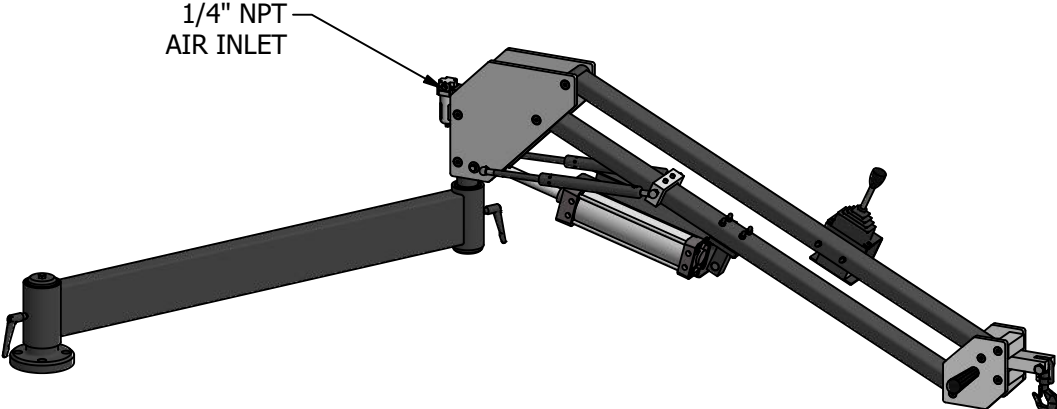

LOAD (LBS)	PRESSURE (PSI)	HEIGHT DIM
150#	115 PSI	35"
90#	120 PSI	52"

- HEIGHT DIMENSIONS VARY DEPENDING ON LOAD AND AIR PRESSURE
- MAXIMUM ALLOWABLE AIR PRESSURE OF 135 PSI
- MAXIMUM LOAD OF 150 LBS



<i>Date:</i> 3/30/2020	<i>Tolerance:</i> .00.....±.010 DECIMAL: .000.....±.005 .0000.....±.0005	<i>Drawn By:</i> crieman	<i>Option No.:</i> PM
<i>Name:</i> PM 44-S WORKING RANGE			
<i>Material Specs:</i>			<i>Sheet:</i> 1 OF 1
Flex  arm [™] Tapping & Assembly Arm Solutions		<i>Part No.:</i> PM 44-S	